

# Clutch Covers *Envolturas de Embrague Cloche d'Embrayage*

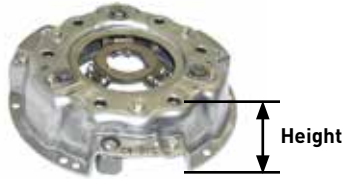
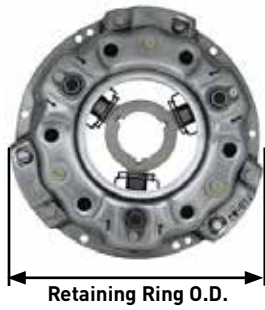

	Description	Retaining Ring O. D. ▼	Clutch Height
SY88282	With bearing	8.90" 227mm	1.85" 53mm
			
SY51744	With diaphragm	8.90" 226mm	1.89" 48mm
			
SY88283	With regular fingers	8.90" 225mm	2.46" 63mm
			
SY88284	With regular fingers	8.90" 225mm	2.48" 63mm
			
SY940505	With regular fingers	10.04" 255mm	2.52" 64mm
			
SY88273	With regular fingers	10.71" 276mm	2.23" 76mm
			

# Clutch Covers Envoladuras de Embrague Cloche d'Embrayage

	Description	Retaining Ring O. D. ▼	Clutch Height
SY88286	With bearing	10.83" 275mm	2.72" 69mm
			
SY51745	With regular fingers	10.83" 275mm	2.72" 69mm
			
SY88285	With bearing	10.90" 276mm	2.72" 69mm
			
SY51746	With regular fingers	10.91" 277mm	2.72" 69mm
			
SY88287	With bearing	10.87" 276mm	2.72" 69mm
			
SY56660	With regular fingers	12.85" 327mm	2.83" 72mm
			
SY46226	With regular fingers	12.91" 328mm	2.99" 76mm
			
SY32689	With regular fingers	13.94" 354mm	2.95" 75mm
			

# Clutch Friction Plates Slacas del Fricción de Embrague Disques d'Embrayage











Lining O.D.



Height of Boss

	Lining O. D. ▼		Height of Boss		Splines	Lining Type	Dampening Type	Bush
SY940383	6.50"	165mm						Excentric
								
SY82374	8.82"	224mm	1.02"	26mm	10	Dry	Spring	Excentric
								
SY88368	8.86"	225mm	1.14"	29mm	13	Dry	Spring	Excentric
								
SY88373	8.86"	225mm	1.12"	29mm	21	Dry	Rubber	Excentric
								
SY940376	9.88"	251mm	1.22"	31mm	18	Dry	Spring	Excentric
								
SY40380	10.00"	254mm	1.40"	36mm	10	Dry		Excentric
								
SY51749	10.83"	275mm	1.37"	35mm	10	Dry	Spring	Excentric
								

# Clutch Friction Plate **Slacas del Fricción de Embrague** Disques d'Embrayage

	<b>Lining O. D. ▼</b>		Height of Boss		Splines	Lining Type	Dampening Type	Bush
SY47316	10.83"	275mm	1.18"	30mm	12	Dry	Spring	Excentric
								
SY88369	10.83"	275mm	1.10"	28mm	13	Dry	Spring	Excentric
								
SY940378	10.83"	275mm	1.16"	29mm	21	Dry	Spring	Excentric
								
SY88371	10.87"	275mm	1.38"	35mm	10	Dry	Spring	Excentric
								
SY88370	10.91"	277mm	1.17"	30mm	18	Dry	Spring	Excentric
								
SY38622	11.02"	280mm	1.49"	38mm	10	Dry		Excentric
								
SY36169	11.89"	302mm	1.48"	38mm	10	Oil (wet clutch)		Excentric
								
SY38573	11.89"	302mm	1.51"	38mm	10	Oil (wet clutch)		Excentric
								
SY940374	12.77"	324mm	1.57"	40mm	16	Dry	Spring	Excentric
								

# Transmission Discs Discos de Transmisión Disques de Transmission

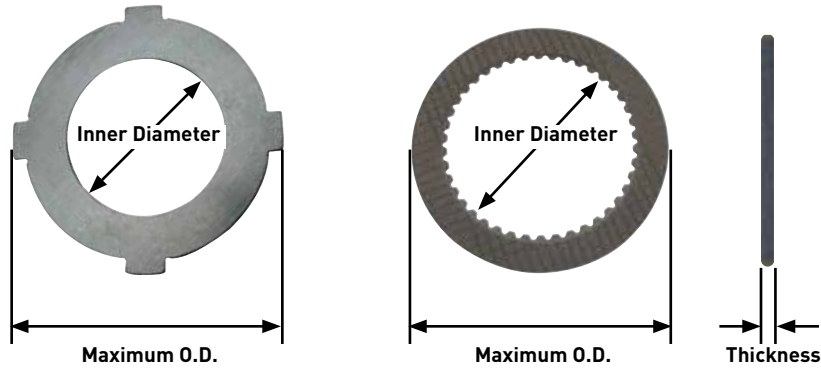

	Type	Maximum O. D. ▼		I. D.		Thickness of Lining	Teeth	Teeth Position	Composite Lining Material
SY41756	2 pass	4.626"	118mm	2.685"	68mm	0.087" 2.2mm	33	Int	Paper
									
SY34777	Steel plate	4.823"	123mm	2.366"	60mm	0.118" 3.0mm	24	Int	Steel
									
SY34783	Sunburst	4.906"	125mm	2.717"	69mm	0.122" 3.1mm	41	Int	Bronze
									
SY36983	2 pass	4.913"	125mm	2.697"	69mm	0.142" 3.6mm	41	Int	Paper
									
SY940382	2 pass	4.920"	125mm	2.700"	69mm	0.106" 2.7mm	41	Int	Paper
									
SY940377	Waffle	4.920"	125mm	2.700"	69mm	0.122" 3.1mm	41	Int	Paper
									

# Transmission Discs Discos de Transmisión Disques de Transmission

	Type	Maximum O. D. ▼		I. D.		Thickness of Lining	Teeth	Teeth Position	Composite Lining Material
SY940379	2 pass	4.920"	125mm	2.710"	69mm	0.102" 2.6mm	41	Int	Graphite
									
SY97295	2 pass	4.921"	125mm	2.697"	69mm	0.102" 2.6mm	41	Int	Paper
									
SY34784	Sunburst	4.921"	125mm	2.697"	69mm	0.118" 3.0mm	41	Int	Bronze
									
SY97562	Waffle	4.921"	125mm	2.697"	69mm	0.106" 2.7mm	41	Int	Graphite
									
SY85844	2 pass	5.000"	127mm	3.228"	82mm	0.110" 2.8mm	40	Int	Bronze
									
SY34778	2 pass	5.071"	129mm	3.150"	80mm	0.087" 2.2mm	50	Ext	Graphite
									
SY38963	Steel plate	5.079"	129mm	2.917"	74mm	0.197" 5.0mm	4	Ext	Steel
									
SY41731	Steel plate	5.079"	129mm	2.992"	76mm	0.059" 1.5mm	4	Ext	Steel
									

# Transmission Discs Discos de Transmisión Disques de Transmission

	Type	Maximum O. D. ▼		I. D.		Thickness of Lining		Teeth	Teeth Position	Composite Lining Material
SY34805	Waffle	5.146"	131mm	3.122"	79mm	0.102" 2.6mm		30	Int	Paper
										
SY48108	Steel plate	5.161"	131mm	3.134"	80mm	0.063" 1.6mm		8	Ext	Steel
										
SY23619	Steel plate	5.180"	132mm	3.150"	80mm	0.063" 1.6mm		42	Ext	Steel
										
SY34795	Steel plate	5.189"	132mm	3.150"	80mm	0.063" 1.6mm		24	Ext	Steel
										
SY940384	Waffle	5.250"	133mm	3.660"	93mm	0.102" 2.6mm		45	Int	Graphite
										
SY46782	2 pass	5.256"	134mm	3.654"	93mm	0.081" 2.2mm		43	Int	Paper
										
SY41569	Radial	5.256"	134mm	3.661"	93mm	0.090" 2.3mm		45	Int	Graphite
										
SY34796	2 pass	5.276"	134mm	3.051"	78mm	0.114" 2.9mm		38	Int	Paper
										

# Transmission Discs Discos de Transmisión Disques de Transmission

	Type	Maximum O. D. ▼		I. D.		Thickness of Lining		Teeth	Teeth Position	Composite Lining Material
SY34790	Steel plate	5.413"	138mm	3.146"	80mm	0.090"	2.3mm	4	Ext	Steel
										
SY34785	Steel plate	5.433"	138mm	3.150"	80mm	0.126"	3.2mm	4	Ext	Steel
										
SY31314	Steel plate	5.465"	139mm	3.898"	99mm	0.118"	3.0mm	54	Ext	Steel
										
SY46709	Steel plate	5.465"	139mm	3.898"	99mm	0.118"	3.0mm	54	Ext	Steel
										
SY940385	Steel plate	5.470"	139mm	3.900"	99mm	0.079"	2.0mm	54	Ext	Steel
										
SY41481	Steel plate	5.472"	139mm	3.898"	99mm	0.067"	1.7mm	54	Ext	Steel
										
SY97564	Steel plate	5.472"	139mm	3.898"	99mm	0.079"	2.0mm	54	Ext	Steel
										
SY34797	Steel plate	5.484"	139mm	3.433"	87mm	0.091"	2.3mm	54	Ext	Steel
										



# Transmission Discs Discos de Transmisión Disques de Transmission

	Type	Maximum		I. D.		Thickness of Lining		Teeth	Teeth Position	Composite Lining Material
		O. D. ▼								
SY34803	Steel plate	5.630"	143mm	3.484"	89mm	0.079"	2.0mm	6	Ext	Steel
										
SY34804	Steel plate	5.638"	143mm	3.484"	89mm	0.079"	2.0mm	6	Ext	Steel
										
SY34768	Steel plate	5.642"	143mm	3.520"	89mm	0.089"	2.3mm	26	Ext	Steel
										
SY41400	Radial	5.847"	149mm	4.232"	108mm	0.102"	2.6mm	52	Int	Bronze
										
SY34776	2 pass	5.847"	149mm	4.236"	108mm	0.071"	1.8mm	52	Int	Paper
										
SY41631	2 pass	5.847"	149mm	4.236"	108mm	0.114"	2.9mm	52	Int	Paper
										
SY41504	Radial	5.847"	149mm	4.236"	108mm	0.102"	2.6mm	52	Int	Bronze
										
SY236989	Radial	5.847"	149mm	4.236"	108mm	0.114"	2.9mm	52	Int	Bronze
										

# Transmission Discs Discos de Transmisión Disques de Transmission

	Type	Maximum O. D. ▼		I. D.		Thickness of Lining		Teeth	Teeth Position	Composite Lining Material
SY51766	2 pass	5.890"	150mm	4.240"	108mm	0.102" 2.6mm		42	Int	Paper
										
SY34775	Steel plate	6.055"	154mm	4.500"	114mm	0.122" 3.1mm		60	Ext	Steel
										
SY41346	Steel plate	6.071"	154mm	4.488"	114mm	0.071" 1.8mm		60	Ext	Steel
										
SY940381	2 pass	6.120"	156mm	3.500"	89mm	0.102" 2.6mm		29	Int	Graphite
										
SY34791	2 pass	6.126"	156mm	3.461"	88mm	0.102" 2.6mm		37	Int	Paper
										
SY34787	Steel plate	6.185"	157mm	3.953"	100mm	0.055" 1.4mm		8	Ext	Steel
										
SY41284	Steel plate	6.335"	161mm	4.067"	103mm	0.063" 1.6mm		42	Ext	Steel
										
SY97648	Waffle	6.339"	161mm	4.232"	108mm	0.112" 2.8mm		52	Int	Graphite
										

# Transmission Discs Discos de Transmisión Disques de Transmission

	Type	Maximum		I. D.		Thickness		Teeth	Teeth	Composite
		O. D. ▼				of Lining				
SY51764	Steel plate	6.347"	161mm	4.496"	114mm	0.071"	1.8mm	8	Ext	Steel
										
SY41333	Steel plate	6.358"	162mm	4.563"	116mm	0.067"	1.7mm	4	Ext	Steel
										
SY38335	Steel plate	6.520"	166mm	3.937"	100mm	0.079"	2.0mm	12	Ext	Steel
										
SY39757	Steel plate	6.693"	170mm	3.937"	100mm	0.091"	2.3mm	6	Ext	Steel
										
SY31444	Steel plate	6.941"	176mm	4.043"	103mm	0.079"	2.0mm	36	Int	Steel
										
SY44598	Steel plate	7.528"	191mm	4.622"	117mm	0.079"	2.0mm	20	Ext	Steel
										
SY43817	2 pass	7.728"	196mm	5.441"	138mm	0.110"	2.8mm	44	Int	Paper
										
SY43990	Sunburst	7.736"	197mm	5.445"	138mm	0.110"	2.8mm	44	Int	Bronze
										

# Transmission Discs Discos de Transmisión Disques de Transmission

	Type	Maximum O. D. ▼		I. D.		Thickness of Lining		Teeth	Teeth Position	Composite Lining Material
SY940392	Sunburst	7.874"	200mm	2.323"	59mm	0.177"	4.5mm	20	Int	Graphite
										
SY940388	Sunburst	7.910"	201mm	1.610"	41mm	0.197"	5.0mm	16	Int	Graphite
										
SY43816	Steel plate	8.071"	205mm	5.724"	145mm	0.142"	3.6mm	43	Ext	Steel
										
SY940393	Steel plate	8.465"	215mm	5.685"	144mm	0.118"	3.0mm	5	Ext	Steel
										
SY34773	2 pass	8.504"	216mm	5.323"	135mm	0.181"	4.6mm	54	Int	Paper
										
SY940387	2 pass	8.660"	220mm	3.560"	91mm	0.157"	4.0mm	47	Int	Paper
										
SY940389	Waffle	9.020"	229mm	1.770"	45mm	0.224"	5.7mm	14	Int	Paper
										
SY97646	Steel plate	9.055"	230mm	5.512"	140mm	0.126"	3.2mm	3	Ext	Steel
										

# Transmission Discs Discos de Transmisión Disques de Transmission

	Type	Maximum		I. D.		Thickness of Lining		Teeth	Teeth Position	Composite Lining Material
		O. D. ▼								

SY940390	Waffle	9.530"	242mm	1.410"	36mm	0.228"	5.8mm	14	Int	Paper
----------	--------	--------	-------	--------	------	--------	-------	----	-----	-------



SY940386	Steel plate	10.220"	260mm	6.810"	173mm	0.197"	5.0mm	8	Ext	Steel
----------	-------------	---------	-------	--------	-------	--------	-------	---	-----	-------



SY45428	Steel plate	10.626"	270mm	7.760"	197mm	0.138"	3.5mm	64	Int	Steel
---------	-------------	---------	-------	--------	-------	--------	-------	----	-----	-------



SY947058	Steel plate	11.980"	304mm	8.374"	213mm	0.098"	2.5mm	12	Ext	Steel
----------	-------------	---------	-------	--------	-------	--------	-------	----	-----	-------







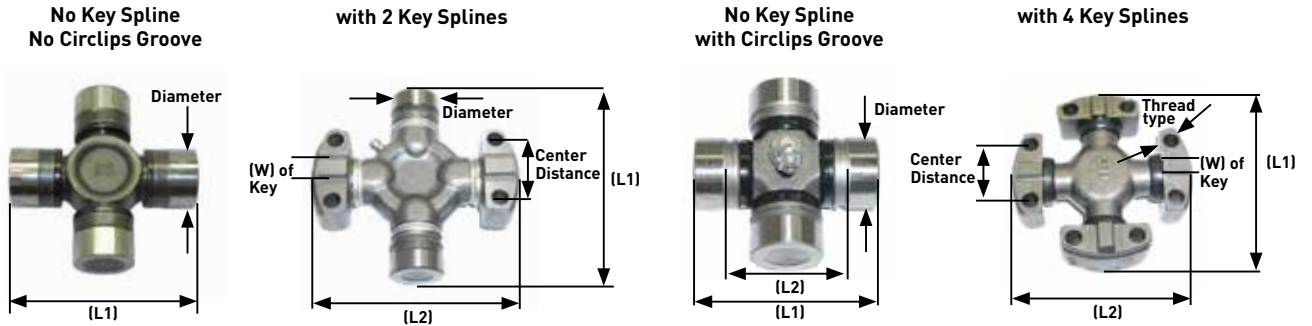

SY97559	Steel plate	18.181"	462mm	13.780"	350mm	0.134"	3.4mm	72	Ext	Steel
---------	-------------	---------	-------	---------	-------	--------	-------	----	-----	-------













# U-Joints Juntas en U Joints en U













	Type ▼	Length (L1)	Length (L2)	Center Distance	Width of Key	Diameter	Thread Type	Pitch	RH or LH Thread	Grease Nipple
 SY52456	No key spline No circlips groove	2.165" 55mm				0.787" 20mm				None
 SY97226	No key spline With circlips groove	2.331" 59mm	1.547" 39mm			0.790" 20mm				None
 SY1244472	No key spline No circlips groove	2.339" 59mm				0.866" 22mm				Present
 SY940398	No key spline No circlips groove	2.343" 60mm				0.787" 20mm				None
 SY71916	No key spline No circlips groove	2.362" 60mm	1.622" 41mm			0.866" 22mm				None
 SY108310	No key spline With circlips groove	2.362" 60mm	1.654" 42mm			0.870" 22mm				None
 SY23231	No key spline With circlips groove	2.362" 60mm	1.547" 39mm			0.933" 24mm				Present

# U-Joints Juntas en U Joints en U



	Type ▼	Length (L1)	Length (L2)	Center Distance	Width of Key	Diameter	Thread Type	Pitch	RH or LH Thread	Grease Nipple
SY97305	No key spline With circlips groove	2.560" 65mm	1.772" 45mm			0.980" 25mm				Present
										
SY940394	No key spline No circlips groove	2.705" 69mm	1.780" 45mm			0.984" 25mm				Present
										
SY97301	No key spline With circlips groove	3.177" 81mm	2.382" 61mm			0.980" 25mm				Present
										
SY97224	No key spline No circlips groove	3.669" 93mm	1.189" 30mm							None
										
SY97300	No key spline With circlips groove	4.205" 107mm				1.180" 30mm				Present
										
SY940399	No key spline No circlips groove	4.213" 107mm				1.378" 35mm				Present
										
SY940417	With 2 key splines	3.673" 93mm	3.602" 92mm	1.457" 37mm	0.374" 10mm	1.124" 29mm				Present
										
SY51776	With 2 key splines	4.213" 107mm	4.252" 108mm	1.437" 37mm	0.374" 10mm	1.122" 29mm				Optional
										
SY107750	With 2 key splines	4.252" 108mm	4.567" 116mm	1.693" 43mm	0.551" 14mm	1.122" 29mm				Present
										
SY940418	With 2 key splines	4.539" 115mm	4.764" 121mm	1.693" 43mm	0.559" 14mm	1.260" 32mm				Present
										

# U-Joints Juntas en U Joints en U

	Type ▼	Length (L1)	Length (L2)	Center Distance	Width of Key	Diameter	Thread Type	Pitch	RH or LH Thread	Grease Nipple
SY71738	With 2 key splines	4.591" 117mm	4.555" 116mm		0.559" 14mm	1.340" 34mm				Present
										
SY52351	With 2 key splines	4.969" 126mm	5.327" 135mm	1.673" 43mm	0.551" 14mm	1.374" 35mm				None
										
SY47515	With 4 key splines		3.122" 79mm	1.299" 33mm	0.374" 10mm			5/16" UNF	RH	Present
										
SY47516	With 4 key splines		3.122" 79mm	1.319" 34mm	0.374" 10mm					Present
										
SY42694	With 4 key splines		4.252" 108mm	1.417" 36mm	0.374" 10mm					Present
										
SY23200	With 4 key splines		4.520" 115mm	1.693" 43mm	0.559" 14mm			3/8" UNF	RH	None
										
SY45403	With 4 key splines		4.535" 115mm	1.673" 43mm	0.563" 14mm			3/8" UNF	RH	Present
										
SY46624	With 4 key splines		4.535" 115mm	1.693" 43mm	0.563" 14mm			3/8" UNF	RH	None
										
SY32132	With 4 key splines		4.539" 115mm	1.693" 43mm	0.559" 14mm					Optional
										
SY97302	With 4 key splines		5.539" 141mm	1.693" 43mm	0.559" 14mm			3/8" UNF		None
										



# U-Joints Juntas en U Joints en U

	Type ▼	Length (L1)	Length (L2)	Center Distance	Width of Key	Diameter	Thread Type	Pitch	RH or LH Thread	Grease Nipple
SY45553	With 4 key splines		5.524" 140mm	1.693" 43mm	0.559" 14mm			3/8" UNF	RH	Present
										
SY43888	With 4 key splines		5.847" 149mm	1.929" 49mm	0.630" 16mm			7/16" UNF	RH	Present
										

## Drive Shafts Eje de Accionamiento Arbres d'entraînement

### Types

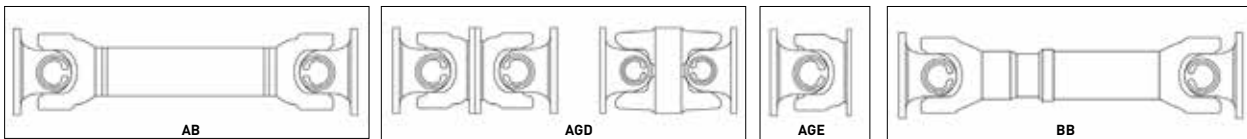

### Type of Connection



### Dimensions





# Drive Shafts Eje de Accionamiento Arbres d'entraînement

	Type of Shaft ▼	Length	Length L2	Diameter Shaft D1	Type of Connection 1	Diameter D2	Diameter D3	Length L3	Length L4	Number of Holes	Diameter D4	Dist. Between Center C1	Dist. Between Center C2	Number of Splines
SY108309	AB	9.213" 234mm		0.984" 25mm	A&D			3.031" 77mm	3.031" 77mm	4	0.354" 9mm	2.244" 57mm	2.244" 57mm	10
														
SY800036614	AB	10.315" 262mm	10.197" 259mm	1.614" 41mm	A&D		2.244" 57mm	2.638" 67mm	2.913" 74mm	4	0.331" 8mm	1.772" 45mm	2.102" 53mm	14
														
SY108318	AB	10.669" 271mm		1.260" 32mm	A&D			3.150" 80mm	3.150" 80mm	4	0.327" 8mm	2.205" 56mm	2.205" 56mm	10
														
SY78072	AB	10.945" 278mm	10.748" 273mm	2.032" 51mm	A&D		1.772" 45mm	2.717" 69mm	3.070" 78mm	4	0.354" 9mm	1.496" 38mm	2.047" 52mm	11
														
SY800134972	AB	11.260" 286mm		1.614" 41mm	A&D			3.150" 80mm	3.150" 80mm	4	0.335" 9mm	2.224" 57mm	2.224" 57mm	13
														
SY940415	AB	11.929" 303mm	11.811" 300mm	2.520" 64mm	A&D		2.244" 57mm	2.598" 66mm	2.795" 71mm	4	0.315" 8mm	1.772" 45mm	2.126" 54mm	13
														
SY940413	AB	14.016" 356mm		1.181" 30mm	A&D			3.150" 80mm	3.150" 80mm	4	0.327" 8mm	2.224" 57mm	2.224" 57mm	13
														
SY937630	AGD	3.110" 79mm	0.803" 20mm	3.346" 85mm	B&B	3.110" 79mm				4	0.327" 8mm	1.319" 34mm	2.362" 60mm	
														
SY44249	AGD	3.110" 79mm	0.807" 21mm	3.346" 85mm	B&B	3.130" 80mm				4	0.335" 9mm	1.319" 34mm	2.362" 60mm	
														
SY940397	AGD	3.150" 80mm	0.827" 21mm	3.346" 85mm	B&B	3.126" 79mm				4	0.331" 8mm	1.229" 33mm	2.382" 61mm	
														

# Drive Shafts Eje de Accionamiento Arbres d'entraînement

	Type of Shaft	Length	Length L2	Diameter Shaft D1	Type of Connection 1	Diameter D2	Diameter D3	Length L3	Length L4	Number of Holes	Diameter D4	Dist. Between Center C1	Dist. Between Center C2	Number of Splines
SY940431	AGD	4.055" 103mm			B&B	4.252" 108mm				4	0.354" 9mm	1.437" 37mm	3.445" 88mm	
														
SY800121881	AGD	4.331" 110mm			B&B	4.252" 108mm				4	0.335" 9mm	1.457" 37mm	3.465" 88mm	
														
SY96659	AGD	4.409" 112mm	4.094" 104mm		B&B	4.528" 115mm					0.413" 11mm	1.693" 43mm	3.543" 90mm	
														
SY45843	AGD	4.488" 114mm	1.378" 35mm	4.764" 121mm	B&B	4.528" 115mm				4	0.413" 11mm	1.693" 43mm	3.504" 89mm	
														
SY940414	AGD	4.488" 114mm	4.488" 114mm		B&B	4.528" 115mm				4	0.413" 11mm	1.693" 43mm	3.543" 90mm	
														
SY937632	AGD	4.528" 115mm			B&B	4.283" 109mm				4	0.335" 9mm	1.437" 37mm	3.425" 87mm	
														
SY108308	AGD	5.118" 130mm	2.756" 70mm	3.346" 85mm	B&B	3.110" 79mm				4	0.335" 9mm	1.339" 34mm	2.362" 60mm	
														
SY71915	AGD	5.394" 137mm	5.315" 135mm		A&D		1.496" 38mm	2.598" 66mm	2.992" 76mm	4	0.327" 8mm	1.575" 40mm	2.244" 57mm	13
														
SY108307	AGD	5.827" 148mm	0.925" 24mm	4.488" 114mm	B&D	4.252" 108mm				4	0.354" 9mm	1.457" 37mm	3.465" 88mm	10
														
SY937633	AGD	6.142" 156mm			A&D			3.110" 79mm	3.110" 79mm		0.335" 9mm	2.224" 57mm	2.224" 57mm	13
														
SY940416	AGD	6.161" 157mm			B&B	3.563" 91mm				4	0.339" 9mm	1.417" 36mm	2.756" 70mm	
														

# Drive Shafts Eje de Accionamiento Arbres d'entraînement

	Type of Shaft ▼	Length	Length L2	Diameter Shaft D1	Type of Connection 1	Diameter D2	Diameter D3	Length L3	Length L4	Number of Holes	Diameter D4	Dist. Between Center C1	Dist. Between Center C2	Number of Splines
SY1220257	AGD	6.299" 160mm			A&D			3.150" 80mm	3.150" 80mm	4	0.335" 9mm	2.205" 56mm	2.205" 56mm	13
														
SY47539	AGD	6.300" 160mm			A&D			3.150" 80mm	3.150" 80mm	4	0.335" 9mm	2.224" 57mm	2.224" 57mm	10
														
SY940402	AGD	6.457" 164mm	4.567" 116mm		A&D		1.732" 44mm	3.070" 78mm	3.070" 78mm	4	0.354" 9mm	2.205" 56mm	2.205" 56mm	13
														
SY940403	AGD	6.890" 175mm			A&D			3.070" 78mm	3.070" 78mm	4	0.354" 9mm	2.224" 57mm	2.224" 57mm	13
														
SY108315	AGD	7.283" 185mm			A&D			3.047" 77mm	3.047" 77mm	4	0.354" 9mm	2.232" 57mm	2.232" 57mm	10
														
SY940532	AGD	7.283" 185mm	7.126" 181mm		A&D		1.654" 42mm	2.441" 62mm	3.189" 81mm	4	0.335" 9mm	1.378" 35mm	2.362" 60mm	13
														
SY940401	AGD	7.323" 186mm			A&D			3.150" 80mm	3.150" 80mm	4	0.354" 9mm	2.224" 57mm	2.224" 57mm	13
														
SY78071	AGD	7.795" 198mm	7.677" 195mm		A&D		1.772" 45mm	2.717" 69mm	3.070" 78mm	4	0.354" 9mm	1.496" 38mm	2.047" 52mm	11
														
SY800131287	AGD	7.992" 203mm			A&D			3.031" 77mm	3.031" 77mm	4	0.335" 9mm	2.244" 57mm	2.244" 57mm	13
														
SY940400	AGD	8.622" 219mm			A&E		2.370" 60mm	3.268" 83mm	3.516" 89mm	4	0.394" 10mm	2.008" 51mm	2.382" 61mm	16
														
SY1237388	AGD	8.700" 221mm			A&D			4.094" 104mm	4.094" 104mm	4	0.433" 11mm	3.070" 78mm	3.070" 78mm	13
														

# Drive Shafts Eje de Accionamiento Arbres d'entraînement

	Type of Shaft ▼	Length	Length L2	Diameter Shaft D1	Type of Connection 1	Diameter D2	Diameter D3	Length L3	Length L4	Number of Holes	Diameter D4	Dist. Between Center C1	Dist. Between Center C2	Number of Splines
SY57958	AGD	9.961" 253mm	1.122" 29mm	5.827" 148mm	D&D									10 & 34
														
SY940396	AGD	11.654" 296mm	11.614" 295mm		A&E		2.362" 60mm	3.228" 82mm	3.504" 89mm	4	0.394" 10mm	2.008" 51mm	2.362" 60mm	16
														
SY97294	AGD	12.087" 307mm	12.024" 305mm		A&E		2.362" 60mm	3.228" 82mm	3.504" 89mm	4	0.394" 10mm	2.008" 51mm	2.402" 61mm	16
														
SY940504	AGD	12.362" 314mm	12.283" 312mm	1.339" 34mm	A&E	3.819" 97mm	1.339" 34mm			4	0.339" 9mm	1.575" 40mm	2.244" 57mm	18
														
SY31544	AGE	3.465" 88mm	3.150" 80mm		A&A		1.772" 45mm	3.189" 81mm	3.189" 81mm	4	0.327" 8mm	1.811" 46mm	2.244" 57mm	
														
SY937631	BB	6.496" 165mm	6.339" 161mm	1.535" 39mm	A&A	3.346" 85mm	1.339" 34mm			4	0.335" 9mm	1.594" 41mm	2.224" 57mm	
														
SY94468	BB	7.323" 186mm	7.165" 182mm	1.535" 39mm	A&A	3.543" 90mm	1.339" 34mm			4	0.335" 9mm	2.756" 70mm		
														
SY940429	BB	7.362" 187mm	7.205" 183mm	1.299" 33mm	A&A	3.465" 88mm	1.339" 34mm	2.638" 67mm		4	0.315" 8mm	1.575" 40mm	2.244" 57mm	
														
SY940395	BB	8.346" 212mm		1.575" 40mm	A&D			3.150" 80mm	3.150" 80mm	4	0.315" 8mm	2.224" 57mm	2.224" 57mm	13
														
SY108317	BB	8.465" 215mm		1.535" 39mm	A&D			3.012" 77mm	3.012" 77mm	4	0.354" 9mm	2.244" 57mm	2.244" 57mm	13
														
SY800133306	BB	8.661" 220mm		1.535" 39mm	A&D			3.070" 78mm	3.070" 78mm	4	0.354" 9mm	2.244" 57mm	2.244" 57mm	10
														

# Drive Shafts Eje de Accionamiento Arbres d'entraînement

	Type of Shaft	Length	Length L2	Diameter Shaft D1	Type of Connection 1	Diameter D2	Diameter D3	Length L3	Length L4	Number of Holes	Diameter D4	Dist. Between Center C1	Dist. Between Center C2	Number of Splines
SY83146	BB	10.433" 265mm	10.315" 262mm	1.929" 49mm	A&A	3.819" 97mm	2.374" 60mm			4	0.374" 10mm	2.008" 51mm	2.362" 60mm	
														
SY940404	BB	11.024" 280mm		1.535" 39mm	A&D		1.732" 44mm	3.031" 77mm	3.031" 77mm	4	0.354" 9mm	2.205" 56mm	2.205" 56mm	10
														
SY940411	BB	11.535" 293mm	11.457" 291mm	1.929" 49mm	A&F	3.819" 97mm	2.370" 60mm			4	0.374" 10mm	3.110" 79mm		
														
SY940407	BB	13.189" 335mm		1.575" 40mm	A&A			3.150" 80mm	3.150" 80mm	4	0.335" 9mm	2.224" 57mm	2.224" 57mm	
														
SY52347	BB	15.157" 385mm	15.039" 382mm	2.032" 51mm	A&A	3.819" 97mm	2.370" 60mm			4	0.374" 10mm	1.969" 50mm	2.362" 60mm	
														
SY940430	BB	15.709" 399mm	15.551" 395mm	1.024" 26mm	A&A	3.346" 85mm	1.339" 34mm			4	0.327" 8mm	2.756" 70mm		
														

# Neutral Switches Interruptores Neutros Interrupteurs Neutres

	Description ▼		Description ▼		Description ▼
SY34277	F/R assembly switch	SY51963	Neutral safety switch	SY31445	Switch
					
SY39183	Inhibitor switch	SY82885	Neutral safety switch	SY36363	Switch
					
SY31248	Neutral safety switch	SY88571	Neutral safety switch	SY88338	Switch
					
SY44802	Neutral safety switch	SY88574	Neutral safety switch	SY41441	Switch kit
					
SY45579	Neutral safety switch	SY41473	Neutral switch		
					
SY46900	Neutral safety switch	SY82905	Neutral switch		
					
SY51773	Neutral safety switch	SY38911	Stop switch		
					

# Axles & Shafts Ejes Axes & Arbres

	Length ▼			Length ▼	
SY940409	4.33"	110mm		SY77799	9.38" 283mm
SY54792	4.78"	121mm		SY41505	9.75" 248mm
SY940412	4.80"	122mm		SY77176	11.73" 298mm
SY92266	5.61"	143mm		SY88826	12.12" 308mm
SY940410	6.06"	154mm		SY109890	12.40" 315mm
SY45683	6.41"	163mm		SY940602	12.79" 325mm
SY83027	7.38"	187mm		SY83318	12.87" 327mm
SY940506	7.44"	189mm		SY78452	12.88" 327mm
SY92259	7.73"	189mm		SY92305	13.23" 311mm
SY92267	8.11"	206mm		SY44072	15.25" 387mm
SY83012	8.45"	214mm		SY94261	15.28" 388mm
SY78525	8.89"	226mm		SY44999	15.30" 389mm
SY92297	9.03"	229mm		SY77865	15.89" 404mm
					



# Axles & Shafts Ejes Axes & Arbres

	Length ▼
SY88816	16.06" 408mm
	
SY77748	16.75" 425mm
	
SY82623	17.13" 435mm
	
SY77749	17.50" 445mm
	
SY46651	20.00" 508mm
	
SY45166	21.50" 546mm
	
SY77747	23.88" 606mm
	
SY97616	24.45" 621mm
	
SY77179	24.46" 621mm
	
SY77746	24.63" 625mm
	

	Length ▼
SY40594	26.38" 670mm
	
SY940408	26.97" 685mm
	
SY940406	34.64" 880mm
	

# Gasket Kits Kits de Empaques Kits de Joints

**Application ▼**

SY88558

CAT 5GB1-UP T25, 30, 35D, TC40D

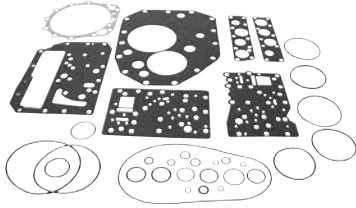

SY88559

CAT V110, V130, V150



SY41134

Clark (235) C500-235, (Y235) C50 lot 2266 and up

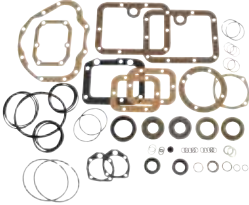

SY41156

Clark (G138MB) GCS20, 25, 30MB lot 5521 and up

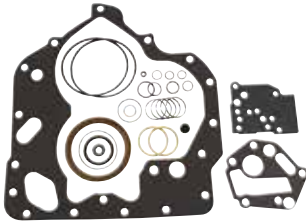

SY41167

Clark (GPX230) GPX20-30



SY88556

Clark (P365L) CGP20, 25, 30

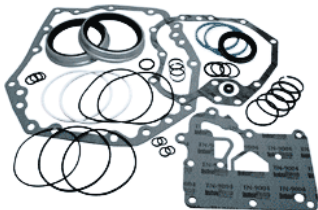

**Application ▼**

SY41132

Clark (Y355) C500-Gas, LPG

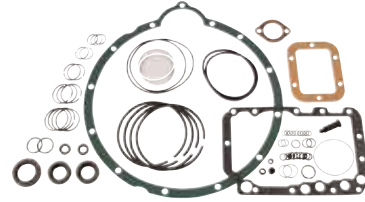

SY41133

Clark (Y685) C500-Y60, 70, 80, 90, 100, S80, S100 GAS/LP (GPX711) lot 9330, 9331 gas

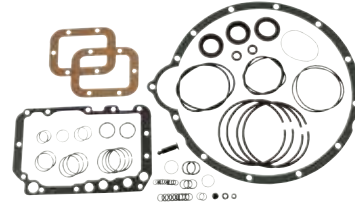

SY41131

Hydratork transmission



SY41151

Hydratork transmission



SY23133

Hyster H150H, H165H, H180H, H200HS, H200H, H225H, H250H, H275H (H7.00HS, H7.50H, H8.00H, H9.00HS, H9.00H, H10.00H, H11.50H, H12.50H)



SY37053

Hyster H150H, H165H, H180H, H200HS, H200H, H225H, H250H, H275H (H7.00HS, H7.50H, H8.00H, H9.00HS, H9.00H, H10.00H, H11.50H, H12.50H)

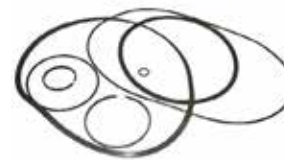

# Gasket Kits Kits de Empaques Kits de Joints

**Application ▼**  
 SY45622 Hyster H30-40-50-60H (D3) diesel, H30-40-50-60H (D3) gas

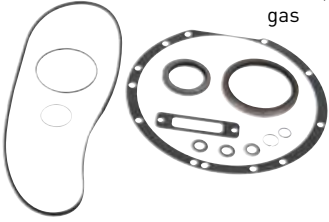

**Application ▼**  
 SY88569 Nissan F03 Series



**Application ▼**  
 SY46914 Hyster H45-50-55-60-65XM (D177) gas, S40-45-50-55-60-65XM (D187) gas H45-50-55-60-65XM (H177) gas

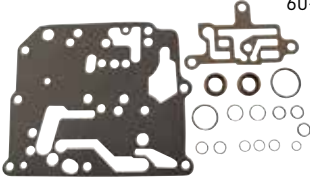

**Application ▼**  
 SY88564 TCM FG9N3, FG10-18N18, FD9Z3, FD10-18Z18, FHG15-18N8, FHG15-18Z8



**Application ▼**  
 SY42316 Hyster H300-360XL, H330XL-EC, H360XL-EC, H13.00-16.00XL H10.00XL-12EC, H12.00XL-12EC



**Application ▼**  
 SY88563 Toyota 7FGCU20, 25, 30, 32



**Application ▼**  
 SY73120 Komatsu FG20, 25, 30SHT-12 FG20, 25, 30ST-12 FG20, 25, 30T-12



**Application ▼**  
 SY23589 Yale GC30-40ADJ, ADN, (1417) 9/88



**Application ▼**  
 SY940424 Mitsubishi FG20/FD20/FG25/FD25

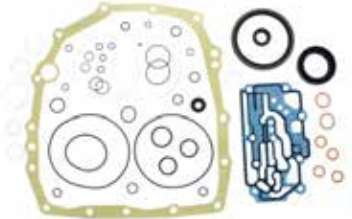

**Application ▼**  
 SY57758 Yale GDP130,140,150,160EB; GDP80-120DB; Hyster H8.00,9.00,10.00,12.0



**Application ▼**  
 SY88562 Nissan F03



# Overhaul Kits Kits de Restauración Kits de Révision

**Application ▼**  
 SY37347 Hyster H45, 50, 55, 60, 65xM



SY37238 Hyster H70, 80, 90, 100, 110XL



SY940423 Hyster S6.00XL/S7.00XL;  
 S135,155XL\_S6.00,7.00;  
 S135XL2/X155XL2



SY940420 Komatsu BX20 Series Forklift



SY97161 Komatsu FD/FG20, 23, 25, 28,  
 30U/H-11

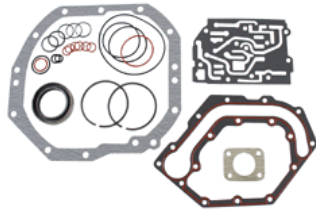

SY1220063 Komatsu FG/FD10, 14, 15,  
 18D/HD/S-15

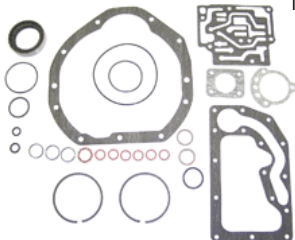

**Application ▼**  
 SY97162 Komatsu FG20, 23, 25, 28, 30  
 (L/S)-8/4 & FD20, 23, 25, 28,  
 30 (S)-5/10

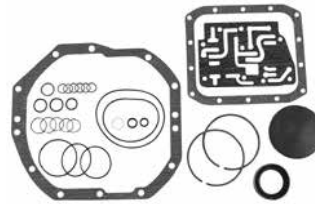

SY940419 Mitsubishi GP15/18/20NM/  
 GP20/25C



SY97164 Toyota 3FD(E) 60, 70, 80

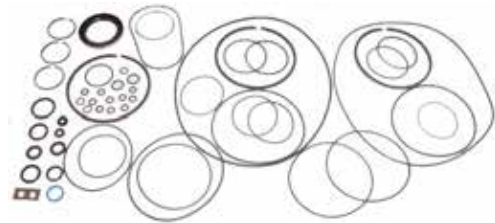

SY97152 Toyota 5FG/FD20, 23, 2

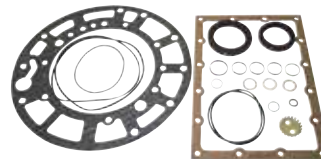

SY97153 Toyota 5FGC/FGF20

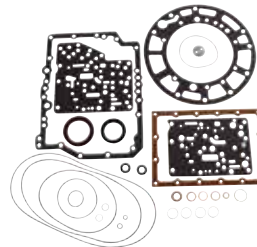

SY97163 Toyota 5FGD15, 18 (89-91)  
 FGD20, 30 (89-91)

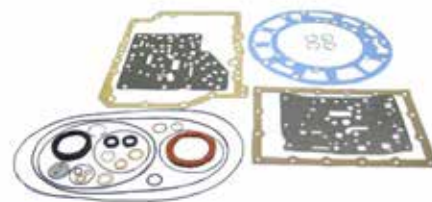

# Overhaul Kits Kits de Restauración Kits de Révision

**Application ▼**

SY97154

Toyota 5FGD15-1B (Sept 91 +)  
5FGD20-30 (Sept 91 +)

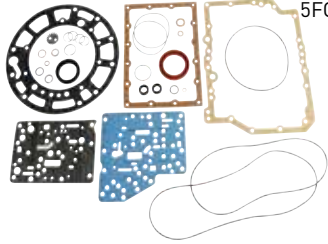

**Application ▼**

SY940422

Toyota 7FD/7FG35,40,45,A50,  
K40

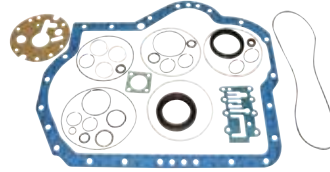

SY97157

Toyota 6FD/FG (A/E) 33, 35,  
40, 45, 50

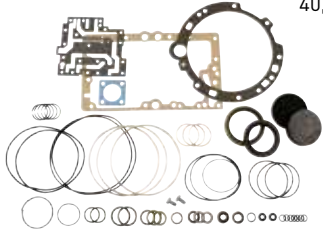

SY937634

Toyota 7FDAU50; 7FDKU40;  
7FDU35,45,60,70,80;  
7FGAU50;  
7FGCU35,45,55,60,70;  
7FGKU40;  
7FGU35,45,60,70,80;



SY97156

Toyota 6FGCU20, 25



SY937635

Toyota 8FDU20,25,30,32;  
8FGU25, 30,32; 02-8FDF20,  
25,30; 02-8FGF20,25,30; 02-  
8FGJF35; 52-8FDF20, 25,30;  
52-8FDJF35;



SY97155

Toyota 6FGD20-25

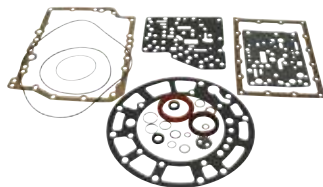

SY971637

Toyota 42-7FG25

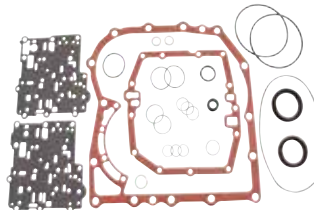

SY97150

Toyota 6FGU-FDU20, 25

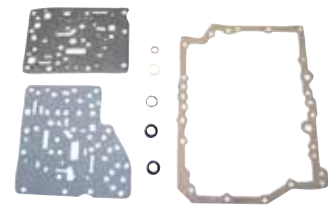

SY940421

Toyota 62-8FD25,62-8FD30,  
02-8FDF30, 72-8FD15, 62-  
8FD15, 02-8FGF15, 52-8FD25



SY97151

Toyota 6FGU-FDU20, 25







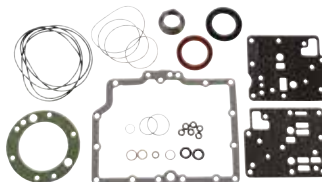

SY82446

Toyota FG28/2FG28, 30/  
FD28/3FD28



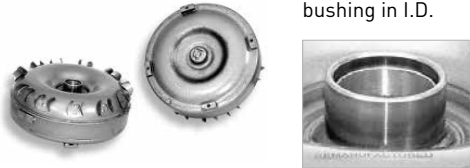
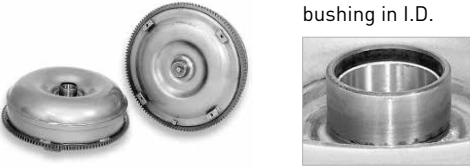







# Remanufactured Torque Converters

Convertidores de Par Remanufacturados Convertisseurs de couple réusinés

	Hub	Size ▼	Pilot (O. D.)	Mount	Stator Splines	Turbine Splines
SY155196R	2 flats 	10.0"	0.787"	Ext. flange with 6 threaded holes	30	14
SY155175R	2 slots 	10.0"	1.143"	4 oblong mounting pads	38	27
SY155067R	Smooth with bushing in I.D. 	10.0"	1.812"	4 pads	27	19
SY155027R	Smooth with bushing in I.D. 	10.0"	1.812"	4 pads with bolt holes 11 1/8" C to C	27	19
SY155136R	2 flats 	10.5"	0.589"	6 threaded holes	30	14
SY155156R	2 flats 	10.5"	0.668"	6 threaded holes not evenly spaced	30	14
SY155178R	2 flats 	10.5"	0.787"	4 threaded pads	30	14
SY155085R	2 flats 	10.5"	1.375"	4 studs	32	29

# Remanufactured Torque Converters

Convertidores de Par Remanufacturados Convertisseurs de couple réusinés

	Hub	Size ▼	Pilot (O. D.)	Mount	Stator Splines	Turbine Splines
SY155086R	2 slots 	10.5"	1.812"	4 pads	29	27
SY155087R	2 slots 	10.5"	1.812"	4 pads	29	27
SY155036R	2 slots 	10.5"	1.812"	4 pads	29	27
SY155035R	Smooth with bushing in I.D. 	10.5"	1.812"	4 pads	29	27
SY155158R	4 eared 	11.0"	0.589"	6 threaded holes	10	18
SY155142R	2 eared 	11.0"	0.589"	6 threaded holes	19	14
SY155144R	Geared with 46 angled teeth 	11.0"	0.589"	6 threaded holes	19	14
SY155152R	2 eared 	11.0"	0.589"	6 threaded holes	19	18

# Remanufactured Torque Converters

Convertidores de Par Remanufacturados Convertisseurs de couple réusinés

	Hub	Size ▼	Pilot (O. D.)	Mount	Stator Splines	Turbine Splines
SY155182R	2 eared	11.0"	0.589"	6 threaded holes	19	18
						
SY155052R	2 eared	11.0"	0.589"	6 threaded holes	19	18
						
SY155050R	2 eared	11.0"	0.589"	6 threaded holes	19	20
						
SY155046R	2 eared	11.0"	0.589"	6 threaded holes	29	20
						
SY155048R	2 eared	11.0"	0.589"	6 threaded holes	29	20
						
SY155190R	2 eared	11.0"	0.589"	6 threaded holes	30	14
						
SY155092R	2 eared	11.0"	0.589"	6 threaded holes	32	18
						
SY155091R	2 flats	11.0"	0.589"	6 threaded holes	32	20
						





# Remanufactured Torque Converters

Convertidores de Par Remanufacturados Convertisseurs de couple réusinés

	Hub	Size ▼	Pilot (O. D.)	Mount	Stator Splines	Turbine Splines
SY155163R	2 flats 	11.0"	0.589"	8 threaded holes	30	14
SY155185R	2 flats 	11.0"	0.589"	8 threaded holes	30	14
SY155116R	2 eared 	11.0"	0.589" x 0.580"L	6 threaded holes	19	14
SY155049R	2 eared 	11.0"	0.589" x 0.580"L	6 threaded holes	19	20
SY155065R	2 eared 	11.0"	0.589" x 0.600"L	4 nuts	19	20
SY155115R	2 eared 	11.0"	0.589" x 0.600"L	4 nuts	19	20
SY155068R	2 eared 	11.0"	0.589" x 0.600"L	4 threaded holes	19	20
SY155026R	2 eared 	11.0"	0.589" x 0.600"L	8 threaded holes	18	14









# Remanufactured Torque Converters

Convertidores de Par Remanufacturados Convertisseurs de couple réusinés

	Hub	Size ▼	Pilot (O. D.)	Mount	Stator Splines	Turbine Splines
SY155069R	2 eared	11.0"	0.589" x 0.600"L	8 threaded holes	18	14
						
SY155073R	2 eared	11.0"	0.589" x 0.635"L	6 threaded holes	19	18
						
SY155090R	2 eared	11.0"	0.589" x 0.895"L	6 threaded holes	19	20
						
SY155023R	2 eared	11.0"	0.589" x 0.580"L	6 threaded holes	19	14
						
SY155040R	Removable geared hub with 8 allen head bolts	11.0"	0.750"	4 square pads with threaded holes	19	15
						
SY155044R	Splined with 41 splines on O.D.	11.0"	0.750"	4 square threaded nuts	19	20
						
SY155212R	2 eared	11.0"	0.750"	4 studs		22
						
SY155227R	46 splines on I.D.	11.0"	0.750"	4 threaded tabs	19	29
						



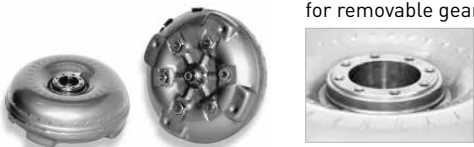





# Remanufactured Torque Converters

Convertidores de Par Remanufacturados Convertisseurs de couple réusinés

	Hub	Size ▼	Pilot (O. D.)	Mount	Stator Splines	Turbine Splines
SY155001R	4 eared	11.0"	0.750"	6 nuts	19	19
						
SY155102R	2 eared	11.0"	0.750"	6 nuts	29	17
						
SY155006R	2 eared	11.0"	0.750"	6 nuts	29	17
						
SY155009R	2 eared	11.0"	0.750"	6 nuts	29	17
						
SY155010R	2 eared	11.0"	0.750"	6 nuts	29	17
						
SY155099R	2 eared	11.0"	0.750"	6 nuts	29	17
						
SY155039R	Flange with 8 threaded holes for removable geared hub	11.0"	0.750"	6 square pads with threaded holes	29	15
						
SY155089R	4 eared with bushing in I.D.	11.0"	0.750"	6 straps	19	15
						







# Remanufactured Torque Converters

Convertidores de Par Remanufacturados Convertisseurs de couple réusinés

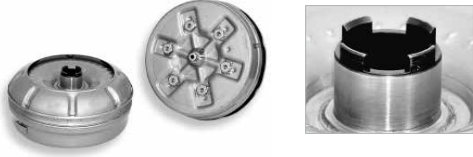
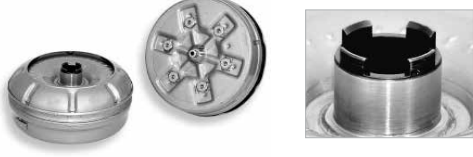
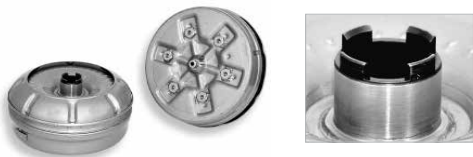
	Hub	Size ▼	Pilot (O. D.)	Mount	Stator Splines	Turbine Splines
SY155012R	2 eared	11.0"	0.750"	6 thick nuts	29	17
						
SY155180R	2 eared	11.0"	0.750"	6 thick nuts	29	17
						
SY155033R	4 eared with bushing in I.D.	11.0"	0.750"	6 threaded nuts	19	15
						
SY155007R	4 eared with bushing in I.D.	11.0"	0.750"	6 threaded nuts	19	15
						
SY155008R	4 eared with bushing in I.D.	11.0"	0.750"	6 threaded nuts	19	15
						
SY155002R	4 eared	11.0"	0.750"	6 threaded nuts	19	19
						
SY155028R	4 eared	11.0"	0.750"	6 threaded nuts	19	19
						
SY155003R	4 eared	11.0"	0.750"	6 threaded nuts	19	19
						



# Remanufactured Torque Converters

Convertidores de Par Remanufacturados Convertisseurs de couple réusinés

	Hub	Size ▼	Pilot (O. D.)	Mount	Stator Splines	Turbine Splines
SY155004R	4 eared	11.0"	0.750"	6 threaded nuts	19	19
						
SY155081R	4 eared	11.0"	0.750"	6 threaded nuts	19	19
						
SY155207R	4 eared	11.0"	0.750"	6 threaded nuts	19	19
						
SY155106R	2 eared	11.0"	0.750"	6 threaded nuts	29	17
						
SY155013R	2 eared	11.0"	0.750"	6 threaded nuts	29	17
						
SY155014R	2 eared	11.0"	0.750"	6 threaded nuts	29	17
						
SY155032R	2 eared	11.0"	0.750"	6 threaded nuts	29	17
						
SY155005R	2 eared	11.0"	0.750"	6 threaded nuts	29	17
						

# Remanufactured Torque Converters

Convertidores de Par Remanufacturados Convertisseurs de couple réusinés

	Hub	Size ▼	Pilot (O. D.)	Mount	Stator Splines	Turbine Splines
SY155107R	2 eared	11.0"	0.750"	6 threaded nuts	29	19
						
SY155113R	2 eared	11.0"	0.750"	6 threaded nuts	29	29
						
SY155024R	2 eared	11.0"	0.750"	6 threaded nuts	29	29
						
SY155153R	2 eared	11.0"	0.750"	6 threaded nuts	29	29
						
SY155181R	2 eared	11.0"	0.750"	6 threaded nuts	29	29
						
SY155186R	2 eared	11.0"	0.750"	6 threaded nuts	29	29
						
SY155187R	2 eared	11.0"	0.750"	6 threaded nuts	29	29
						
SY155188R	2 eared	11.0"	0.750"	6 threaded nuts	29	29
						

# Remanufactured Torque Converters

Convertidores de Par Remanufacturados Convertisseurs de couple réusinés

	Hub	Size ▼	Pilot (O. D.)	Mount	Stator Splines	Turbine Splines
SY155037R	2 eared	11.0"	0.750"	6 threaded nuts	29	29
						
SY155222R	2 eared	11.0"	0.750"	6 threaded nuts	29	29
						
SY155223R	2 eared	11.0"	0.750"	6 threaded nuts	29	29
						
SY155041R	Splined with 44 straight splines	11.0"	0.750"	6 threaded nuts	29	29
						
SY155042R	Splined with 44 straight splines on O.D. of hub	11.0"	0.750"	6 threaded nuts	29	29
						
SY155020R	2 eared	11.0"	0.750"	8 threaded holes	18	14
						
SY155193R	2 eared	11.0"	0.750"	Weld ring with 6 threaded holes	19	19
						
SY155224R	2 eared	11.0"	0.750"	Weld ring with 6 threaded holes	29	29
						

# Remanufactured Torque Converters









Convertidores de Par Remanufacturados Convertisseurs de couple réusinés

	Hub	Size ▼	Pilot (O. D.)	Mount	Stator Splines	Turbine Splines
SY155093R	2 eared 	11.0"	0.787"	4 pads 	19	28
SY155011R	2 eared 	11.0"	0.787"	4 pads 	29	29
SY155157R	Smooth with 50 splines in the I.D. 	11.0"	0.787"	4 round threaded nuts 	29	29
SY155234R	Smooth with 50 splines in the I.D. 	11.0"	0.787"	4 round threaded nuts 	29	29
SY155051R	Splined with 41 splines on O.D. 	11.0"	0.787"	4 square nuts 	19	20
SY155038R	Flange with 8 threaded holes for removable geared hub 	11.0"	0.787"	4 square pads with threaded holes 	19	15
SY155155R	41 splines on the O.D. 	11.0"	0.787"	4 square threaded nuts 	19	20
SY155161R	2 flats 	11.0"	0.787"	6 threaded holes 	30	14











# Remanufactured Torque Converters

Convertidores de Par Remanufacturados Convertisseurs de couple réusinés

	Hub	Size ▼	Pilot (O. D.)	Mount	Stator Splines	Turbine Splines
SY155162R	2 flats 	11.0"	0.787"	6 threaded holes	30	14
SY155201R	2 flats 	11.0"	0.787"	6 threaded holes	30	14
SY155202R	2 flats 	11.0"	0.787"	6 threaded holes	30	14
SY155074R	2 flats 	11.0"	0.787" x 0.660"L	6 threaded holes	30	14
SY155130R	2 flats 	11.0"	0.787" x 0.660"L	6 threaded holes	30	14
SY155131R	2 flats 	11.0"	0.787" x 0.660"L	6 threaded holes	30	14
SY155021R	2 flats 	11.0"	0.787" x 0.660"L	6 threaded holes	30	18
SY155105R	2 flats 	11.0"	0.787" x 0.660"L	6 threaded holes	30	18







# Remanufactured Torque Converters

Convertidores de Par Remanufacturados Convertisseurs de couple réusinés

	Hub	Size ▼	Pilot (O. D.)	Mount	Stator Splines	Turbine Splines
SY155062R	2 flats	11.0"	0.787" x 0.660"L	6 threaded holes	30	18
						
SY155168R	2 eared	11.0"	1.180"	Welded ring with 6 holes	28	26
						
SY155043R	2 slots	11.0"	1.181"	4 pads	38	27
						
SY155179R	4 eared with seal ring groove	11.0"	1.257"	6 oblong threaded nuts	10	18
						
SY155195R	2 flats	11.0"	1.257"	6 square welded nuts	30	14
						
SY155160R	4 eared with seal ring groove	11.0"	1.257"	6 threaded holes	10	18
						
SY155205R	2 slots	11.0"	1.257"	6 threaded nuts	32	18
						
SY155072R	2 flats	11.0"	1.257" x 0.70"L	6 threaded holes	30	14
						

# Remanufactured Torque Converters

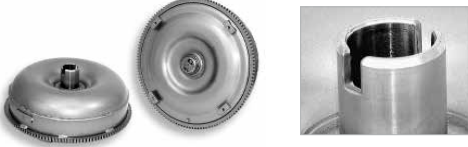
Convertidores de Par Remanufacturados Convertisseurs de couple réusinés

	Hub	Size ▼	Pilot (O. D.)	Mount	Stator Splines	Turbine Splines
SY155197R	2 flats	11.0"	1.375"	4 studs	32	29
						
SY155034R	2 flats	11.0"	1.375"	4 studs	32	29
						
SY155226R	Smooth - no ears or slots	11.0"	1.375"	4 threaded tabs	19	17
						
SY155208R	2 slots	11.0"	1.545"	4 pads	29	18
						
SY155121R	2 slots	11.0"	1.700"	6 pads	27	30
						
SY155122R	2 slots	11.0"	1.700"	6 pads	27	30
						
SY155030R	2 slots	11.0"	1.812"	4 pads	27	24
						
SY155029R	2 slots	11.0"	1.812"	4 pads	29	27
						

# Remanufactured Torque Converters

Convertidores de Par Remanufacturados Convertisseurs de couple réusinés

	Hub	Size ▼	Pilot (O. D.)	Mount	Stator Splines	Turbine Splines
SY155088R	Smooth - no ears or slots  	11.0"	1.812"	4 pads	38	27
SY155108R	2 slots  	11.0"	1.812"	4 threaded pads	29	27
SY155078R	Splined  	11.0"	2.218" hollow pilot	6 threaded nuts	19	20
SY155209R	Smooth - no ears or slots  	11.0"	Non - flange	8 studs	27	19
SY155194R	2 eared  	11.0"	None removable input guide	8 threaded holes - 4 dowel pins	22	18
SY155053R	2 eared  	11.0"		8 threaded holes	18	18
SY155025R	2 flats  	11.0"		8 threaded holes	30	14
SY155176R	Flange for mounting geared hub  	11.5"	0.750"	6 nuts	29	29









# Remanufactured Torque Converters

Convertidores de Par Remanufacturados Convertisseurs de couple réusinés

	Hub	Size ▼	Pilot (O. D.)	Mount	Stator Splines	Turbine Splines
SY155146R 	2 eared 	11.5"	0.750"	7.160 welded ring with 6 holes	19	19
SY155045R 	2 eared 	11.5"	0.787"	4 pads	21	19
SY155228R 	2 eared 	11.5"	0.787"	4 pads	21	19
SY155070R 	Smooth with 50 splines in the I.D. 	11.5"	0.787"	4 square pads	29	29
SY155076R 	41 splines on the O.D. 	11.5"	2.218" hollow pilot	6 threaded nuts	19	20
SY155075R 	2 flats 	12.0"	0.589" x 0.625"L	8 threaded holes	16	19
SY155066R 	2 eared 	12.0"	0.787"	6 nuts	21	19
SY155127R 	Smooth with seal ring groove 	12.0"	1.177"	4 triangular shaped pads	22	18

# Remanufactured Torque Converters

Convertidores de Par Remanufacturados Convertisseurs de couple réusinés

	Hub	Size ▼	Pilot (O. D.)	Mount	Stator Splines	Turbine Splines
SY155095R	2 eared 	12.0"	2.038"	6 threaded holes - 2 dowel pins 	18	16
SY155109R	Smooth 	12.0"	2.038" O.D.	6 threaded holes - 2 dowel pins 	32	15
SY155184R	2 flats 	12.0"	None removable input guide	8 threaded holes 	16	16
SY155198R	2 eared 	12.2"	1.702"	6 oblong threaded nuts 	22	18
SY155200R	2 eared 	12.2"	1.702"	6 oblong threaded nuts 	29	29
SY155174R	2 ears with seal ring groove 	12.5"	0.787"	10 threaded holes 	18	16
SY155094R	2 eared 	12.5"	0.787"	4 oblong threaded pads 	21	19
SY155077R	Smooth with 36 splines in I.D. 	12.5"	1.571" x 0.680" L	4 oblong pads 	22	26

# Remanufactured Torque Converters

Convertidores de Par Remanufacturados Convertisseurs de couple réusinés

	Hub	Size ▼	Pilot (O. D.)	Mount	Stator Splines	Turbine Splines
SY155138R  	Smooth with 36 splines in I.D.	12.5"	1.571" x 0.680"L	4 oblong pads	22	26
SY155135R  	Smooth with seal ring groove	12.5"	1.703" x 0.500"L	4 pads	46	30
SY155166R  	Geared with 37 angled teeth	13.0"	0.589"	8 threaded holes	20/31	20
SY155233R  	Geared with 36 straight teeth on O.D.	13.0"	0.750"	6 threaded holes with 4 dowels	18	19
SY155098R  	Geared with 36 straight teeth on O.D.	13.0"	0.750"	6 threaded holes with 4 dowels	18	19
SY155097R  	Geared with 36 straight teeth	13.0"	0.750" x 1.260"L	6 threaded holes with 4 dowels	18	19
SY155129R  	Smooth with 50 splines in the I.D.	13.0"	0.787"	3 oblong pads	29	29
SY155231R  	2 eared	13.0"	0.787"	6 threaded holes with 2 dowels	16	16

# Remanufactured Torque Converters

















Convertidores de Par Remanufacturados Convertisseurs de couple réusinés

	Hub	Size ▼	Pilot (O. D.)	Mount	Stator Splines	Turbine Splines
SY155170R	2 flats	13.0"	0.787"	8 threaded holes	20/31	20
						
SY155164R	Geared with 37 angled teeth	13.0"	0.787"	8 threaded holes	20/31	20
						
SY155165R	Geared with 37 angled teeth	13.0"	0.787"	8 threaded holes	20/31	20
						
SY155103R	5.115 O.D. geared with 37 slanted teeth at the end	13.0"	0.787" x 1.500"L	5" base 6 holes M10 x 1.5 threads 2 dowel pins	18	19
						
SY155064R	2 eared	13.0"	0.787" x 1.500"L	6 threaded holes	18	13
						
SY155063R	2 eared	13.0"	0.787" x 1.500"L	6 threaded holes	18	19
						
SY155151R	Non-flange for bolt on hub	13.0"	0.982"	6 threaded holes	18	19
						
SY155123R	Geared	13.0"	0.982"	6 threaded holes	27	19
						



# Remanufactured Torque Converters

Convertidores de Par Remanufacturados Convertisseurs de couple réusinés

	Hub	Size ▼	Pilot (O. D.)	Mount	Stator Splines	Turbine Splines
SY155148R	Geared	13.0"	0.982"	6 threaded holes	27	19
						
SY155111R	Geared with 37 angled teeth	13.0"	0.984"	6 threaded holes	18	19
						
SY155140R	41 splines on the O.D.	13.0"	1.700"	3 oblong pads	19	20
						
SY155141R	41 splines on the O.D.	13.0"	1.700"	3 oblong pads	19	20
						
SY155262R	Smooth O.D. with 25 splines on the I.D.	13.0"	1.700"	6 high threaded nuts	19	29
						
SY155229R	Smooth O.D. with 25 splines on the I.D.	13.0"	1.700"	6 high threaded nuts	19	29
						
SY155230R	Smooth O.D. with 25 splines on the I.D.	13.0"	1.700"	6 high threaded nuts	19	29
						
SY155154R	2 eared	13.0"	1.700"	Weld ring with 6 threaded holes	22	29
						

# Remanufactured Torque Converters

Convertidores de Par Remanufacturados Convertisseurs de couple réusinés

	Hub	Size ▼	Pilot (O. D.)	Mount	Stator Splines	Turbine Splines
SY155132R	Smooth with 25 splines on I.D	13.0"	1.702"	6 threaded pads	27	24
						
SY155183R	2 eared	13.0"	1.702" x 0.600"L	3 oblong pads	21	19
						
SY155143R	Geared with 37 angled teeth	13.0"		6 threaded holes	18	19
						
SY155126R	2 eared	13.0"		6 threaded holes with 2 dowels	18	19
						
SY155096R	2 eared	13.0"		6 threaded holes with 2 dowels	18	19
						
SY155177R	Smooth with seal ring groove	14.5"	1.573"	4 threaded pads	46	30
						
SY155236R	Straight with seal ring groove	14.5"	2.358" with 25 splines	Driven by pilot splines	46	30
						

For converters with multiple SY numbers, please contact your sales representative with make, model, and serial number.

Para convertidores con varios números SY, contacte a su representante de ventas con marca, el modelo y número de serie del convertidor.

Pour les convertisseurs ayant plusieurs numéros SY, veuillez contacter votre représentant des ventes avec la marque, le modèle et le numéro de série.

# Torque Converters Convertidores de Par Convertisseurs de Couple

## Dimensions

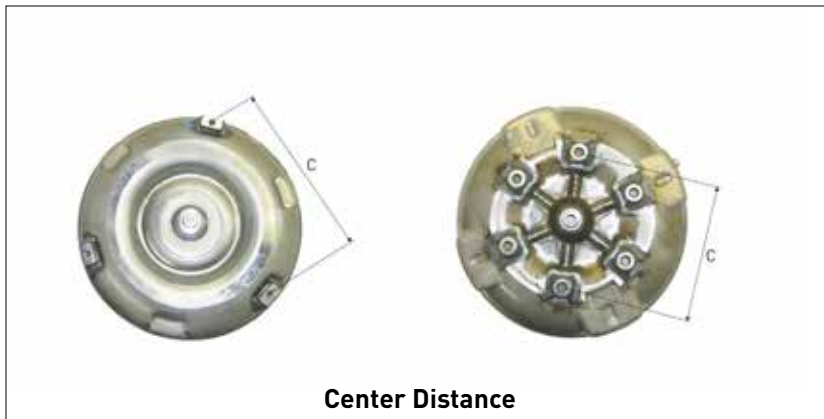
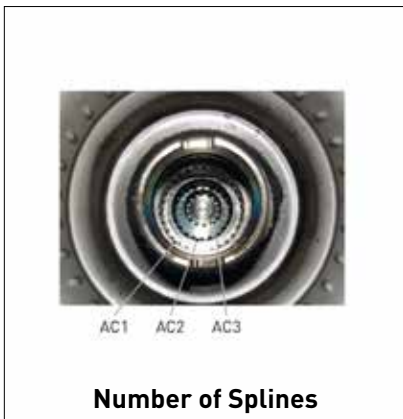
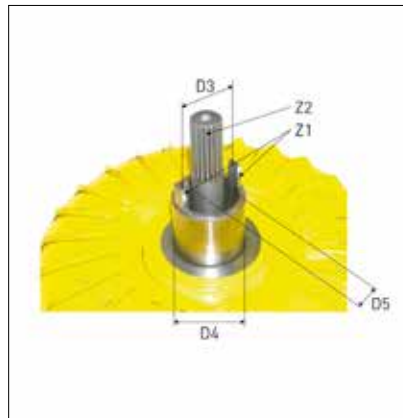
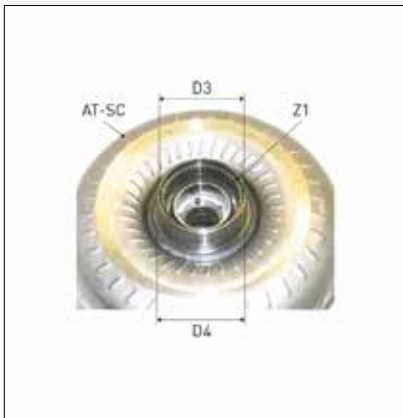
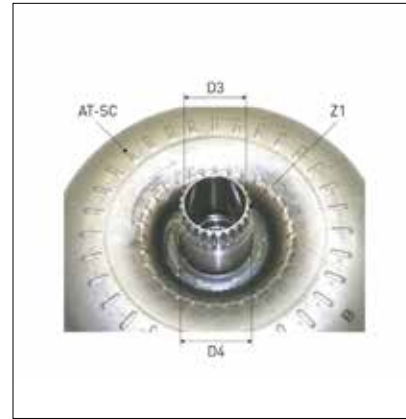
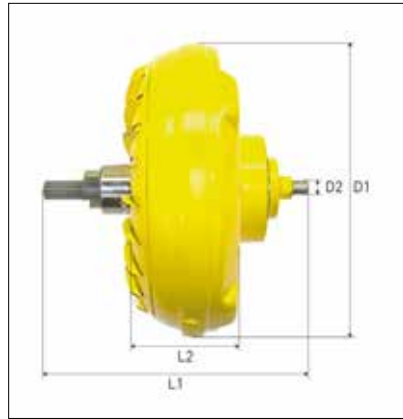

# Torque Converters Convertidores de Par Convertisseurs de Couple

	Type	Diameter D1	Length L1"	Length L2"	Diameter D2	Diameter D3	Diameter D4	Number of Blades	Length L3"	Number of Teeth	Number of Splines AC1	Number of Splines AC2	Number of Holes	Dist. Between Center"	Shaft (Yes/No) ▼
SY937620	Welded	11.024" 280mm	6.969" 177mm	3.937" 100mm	0.787" 20mm	2.362" 35mm	1.654" 42mm	21			30	14	6	3.583" 91mm	No
															
SY97582	Welded	11.083" 282mm	6.575" 167mm	4.134" 105mm	0.591" 15mm	1.378" 35mm	1.654" 42mm	21	1.890" 48mm		30	14	8	3.543" 90mm	No
															
SY940426	Welded	11.220" 285mm	7.244" 184mm	4.016" 102mm	0.591" 15mm	1.390" 35mm	1.654" 42mm	21	1.870" 48mm	2	30	14	8	3.543" 90mm	No
															
SY940425	Welded	11.299" 287mm	6.457" 164mm	4.055" 103mm	1.260" 32mm	1.831" 47mm	2.185" 56mm	31	1.693" 43mm	4	10	18	6	9.646" 245mm	No
															
SY940427	Welded	11.378" 289mm	6.102" 155mm	3.780" 96mm	1.260" 32mm	1.732" 44mm	2.067" 53mm				32	18	6	9.646" 245mm	No
															
SY35068	Welded	11.811" 300mm	6.299" 160mm	4.291" 109mm	0.787" 20mm	1.850" 47mm	2.244" 57mm	31	1.378" 35mm	2	21	19	4	11.417" 290mm	No
															
SY55064	Welded	12.638" 321mm	6.732" 171mm	4.567" 116mm	1.575" 40mm	2.421" 62mm	3.248" 83mm	31	1.496" 38mm	36	22	26	4	9.646" 245mm	No
															
SY937619	Bolted	13.268" 337mm	9.173" 233mm	5.118" 130mm	0.787" 20mm	2.362" 60mm	2.756" 70mm	16		2	18	16	10	5.118" 130mm	No
															
SY88669	Welded	11.102" 282mm	10.236" 260mm	3.661" 93mm	0.591" 15mm	1.614" 41mm	1.969" 50mm	24		2	19		6	3.425" 87mm	Yes
															

# Transmission Pumps Bombas de Transmisión Pompes à Transmission





	Description ▼
SY40360	CAT V30C/V40C/V50C
	
SY52679	Caterpillar 135B/V110-150/59W461; 135A/V110-150/12V610;125/V100-140/59W1
	
SY41753	Clark 12.6 HR 24312-2, 13.9 LFHR 24658-9, 13.9 LFMHR 24658-9
	
SY42064	Clark C500-235-Y235, 355-Y355, 685-Y685
	
SY940513	Clark CMP50,50,70,75(S)D; / CMP50,50,70/CMP75SL; FX50,60,70D/ CMP50-75S; C60L/C70L/C75L
	
SY41515	Clark DPL90/DPL100/DPL120/D
	
SY88714	Clark (GPX230) GPX20-30, (GPX230C) GPX20, 22, 25, 27, 30C LOT 8550 and UP (GX230) GCX20, 22, 25, 27, 30 LOT 7158 and up
	
SY88715	Daewoo-Doosan D20-33S3; D20S-3-D33S-3; GC20,25,30,32P-3; D20,25,30,32E-3; G20P3-G33P3
	

	Description ▼
SY35345	Hyster H.350-4.00-4.50-5.00; YALE 21,22,24FG/FD35,40,45,50P
	
SY34004	Hyster H1.50-2.00XMS; S1.50XMS/ S2.00XMS; H25,30,35XM_H40XMS; H1.50BX/H1.75BX/H2.00
	
SY31430	Hyster H50XL
	
SY45528	Hyster H110F/H130F/H150F; H100C/ H120C/H150C; S60B/S70B/S80B/S90B
	
SY106705	Hyster S25XM/S30XM/S35XM/S40
	
SY44898	Hyster S40-60XM
	
SY32012	Hyster S70-80-100-120XL, S120XLS (D4) gas H70-80-90-100-110-120XM (K5) gas/ LPG H70-80-90-100-110-120XM (K5) diesel update 12/01 update 12/01
	
SY88716	Komatsu FG & FD10, 14, 15, 18-14 FG & FD10D, 14D, 15D, 18D-14 FG & FD10L, 14L, 15L, 18L-14
	

# Transmission Pumps **Bombas de Transmisión** Pompes à Transmission

	Description ▼		Description ▼
SY1210004	Komatsu FG10,14,15,18,20		SY940527 Nissan PM: 1F2UP; PLATINUM II SERIES 1F; MP1F1A20JV/MP1F1A18; AF1UC;1F2;K1F2
SY88717	Komatsu FG20, 25, 30T-11, FG20, 25, 30ST-11		SY88720 TCM FG20-25T7 (A45G) 2004, FHG20-25 T7 (A45G) 2004
SY940428	Mitsubishi FD20N/FD25N; FD15N-FG2; DP30N-DP35N FC/MC; KFG20/25-KF17D; KFD10-18KF3C		SY88721 TCM FG9N3, FG10-18N18, FD9Z3, FD10-18Z18, FHG15-18N8, FHG15-18Z8
SY1068316	Mitsubishi FD20N/FD25N; FD15N-FG2; DP30N-DP35N FC/MC; KFG20/25-KF17D; KFD10-18KF3C		SY97299 Toyota 6FGU-FDU20,25
SY940526	Mitsubishi (K)FD10,14,15,18/(F)G20/K(F)G23/K(F)G; (K)FG10,14,15,18;(K)FD20,23,25-F18A/KF6A		SY71727 Toyota 42-7FG25;(02)-7FD20,25; 7FG/FD10-30,J35,K20,K30
SY88718	Nissan H02 series		SY71725 Toyota FG28/2FG28,30/FD28/3FD28
SY88719	Nissan J02 series		SY97298 Toyota series code G125 MOD code 62-8FD15
SY940531	Nissan PM: H02(EXPORT); J02(UCE) SERIES; KCH02; J02(S); H02(S); T02; QCD20-KM		SY31528 Yale GLP40-60, GC30CE, (1484) 6/92

## Drive Units Unidades de Tracción L'unité d'entraînement

	Application	Type		Application	Type	
SY80580	Hyster J30ZT, J40ZT	New LH		SY96249R	Crown PC/PE/PR/ PW TR/TWR/WB/ WR/WT	Rebuilt
SY96242 SY96242R	Crown RD, RR, RS, 3000, 3500, 4000, SP 3000 SERIES	New Rebuilt		SY96250R	Raymond EZ/EF/ DZ/31G	Rebuilt
SY96244 SY96244R	Crown RD, RR, RS, 5000, 5000S, 5200, 5200S, Rider Reach, Straddle	New Rebuilt		SY96251R	Crown TS/TSP	Rebuilt
SY96247R	Crown RC/SC 3000, 3500, 4000	Rebuilt		SY940502	Yale NR045EA/ NDR035EA; ZF GK25	New
SY96248R	Crown RC/SC 3000, 3500, 4000	Rebuilt				

## Roller Race Jaulas de Rodamientos chemin de roulement

	I.D. (min-max)	Mounting Holes 1	Mounting Holes 2	Thickness
SY43107	13.886" to 13.896"	4 places x 0.531" diameter	2 places x 0.406" diameter	1.344"
	35.270cm to 35.296cm	4 places x 1.349cm diameter	2 places x 1.031cm diameter	3.413cm



# Remanufactured Transmissions Transmisiones Remanufacturadas Transmissions Remises à Neuf



## Features & Benefits

- One year – no hour limit warranty
- All assemblies are thoroughly tested for:
  - Proper clutch engagement
  - Correct pressures are verified
  - Leak test is performed
  - Noise levels
- All units are tested:
  - At operating temperature
  - At several speed intervals
  - By A.S.E. certified technicians
- All wear items are replaced with components that meet or exceed OEM specifications
- Large selections of remanufactured units
- Hundreds of cores
- Items that are always replaced include:
  - Seals
  - Gaskets
  - Bearings
  - Clutch Discs and Separators
  - Springs
  - Thrust Washers
  - Pumps (new or reman)
  - Rings
  - Synchronizers (manual units)

## Transmission Warranty Policy

TVH warrants each remanufactured transmission to be free from defects in material or workmanship for a period of one (1) year, with unlimited hour usage.

The warranty is subject to the following conditions:

- A certified technician must install the unit
- Automatic transmissions must have a new or remanufactured torque converter
- Transmission cooling lines and radiator must be flushed
- All filter lines must be flushed and filters replaced prior to installation
- TVH reserves the option of repairing or replacing any components that are defective in material or workmanship
- TVH must authorize any warranty claim prior to beginning work
- Disassembly of unit without prior authorization from TVH will void the warranty

## Características y Ventajas

- Un año de garantía sin límite de horas
- Todas las asambleas son probadas para:
  - Navegación adecuada del embrague
  - Verificación de presiones correctas
  - Realización de pruebas de fugas
  - Niveles de ruido
- Todas las unidades son probadas:
  - A la temperatura de operación
  - A los varios intervalos de velocidad
  - Por Técnicos Certificados en A.S.E
- Todas las partes sujetas a desgaste son reemplazadas con componentes que cumplen o exceden especificaciones del fabricante original.
- Una gran selección de unidades remanufacturadas
- Cientos de cascos
- Elementos que siempre son reemplazados incluyen:
  - Sellos
  - Empaques
  - Cojinetes
  - Discos de Embrague y Separadores
  - Resortes
  - Arandelas de Empuje
  - Bombas (nuevas o remanufacturadas)
  - Aros
  - Sincronizadores (unidades manuales)

## Póliza de Garantía de la Transmisión

TVH garantiza que el material y la mano de obra de cada transmisión remanufacturada estará libre de defectos por un plazo de un (1) año de uso sin límite de horas.

La garantía está dominada por las siguientes condiciones:

- Un técnico certificado tiene que instalar la unidad
- Transmisiones automáticas deben tener un convertidor de torque nuevo o remanufacturado
- Líneas de enfriador de la transmisión y el radiador deben ser limpiadas
- Todas las líneas de filtro deben ser limpiadas y los filtros reemplazados antes de la instalación
- TVH reserva el derecho de elegir de reparar o reemplazar los componentes que se presenten defectuosos en el material o en la mano de obra
- TVH debe autorizar cualquier reclamación de garantía antes de comenzar el trabajo
- El desmontaje de la unidad sin autorización previa de TVH anulará la garantía

## Caractéristiques et Avantages

- Un an de garantie – Pas d'heures limites de travail pour la garantie.
- Tous les assemblages sont précautionneusement testés sur:
  - Le bon fonctionnement de l'embrayage
  - Correct pressures are verified La pression requise
  - Leak test is performed Les tests de fuites sont effectués
  - Noise levels = Le niveau de sonorité
- Toutes les unités sont testées
  - à température de fonctionnement normal
  - à différentes intervalles de vitesses
  - par des techniciens certifiés A.S.E
- Toutes les pièces usagées sont remplacées par des composants comparables voire plus avancés en termes de spécifications que ceux de l'équipementier d'origine.
- Grande sélection sur les unités remises à neufs
- Les pièces qui sont toujours remplacées sont
  - Joints
  - Joints
  - Bagues Cylindriques
  - Disques d'Embrayage et Séparateurs
  - Ressorts
  - Rondelles d'Arrêts
  - Pompes (Nuevas ou remises à Neuf)
  - Rings Bagues Cylindriques
  - Synchroniseurs (Manuels)

## Politique de Garantie de la Transmisión

TVH garantie chaque transmission remise à neuf pendant un an, que cela soit sur des matériaux défectueux ou un défaut de fabrication, et sans limite d'heures d'usages.

La garantie est sujette aux conditions suivantes:

- Un technicien certifié doit installer la pièce
- Les transmissions automatiques doivent posséder un convertisseur de couple, neuf ou remis à neuf
- Les lignes de refroidissement de la transmission et le radiateur doivent être rincés
- Les lignes de filtres doivent être rincés et les filtres remplacés avant l'installation
- TVH se réserve le droit de réparer ou de remplacer des composants qui seraient défectueux ou ayant des défauts fabrication
- TVH doit autoriser toute demande de fonctionnement de la garantie avant de commencer les travaux
- Le désassemblage de l'unité sans l'autorisation préalable de TVH annule la garantie



